

Data sheet | Item number: 234-507

PCB terminal block; push-button; 0.5 mm<sup>2</sup>; Pin spacing 2.54 mm; 7-pole;  
CAGE CLAMP®

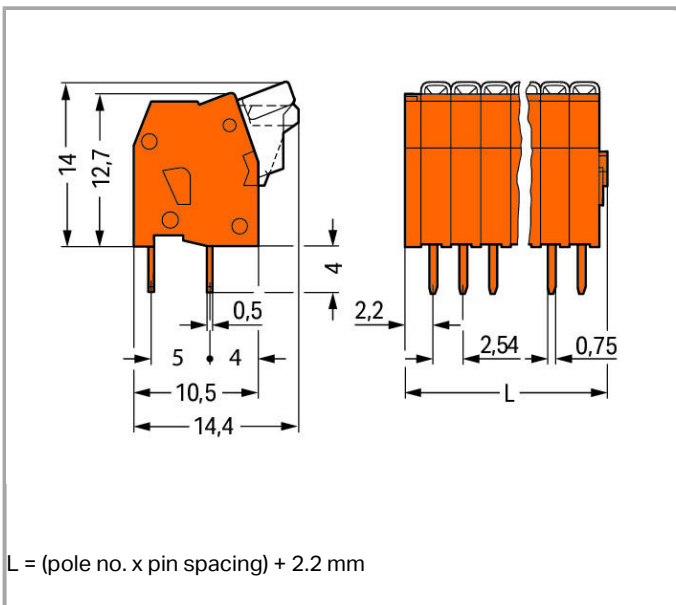

234-507

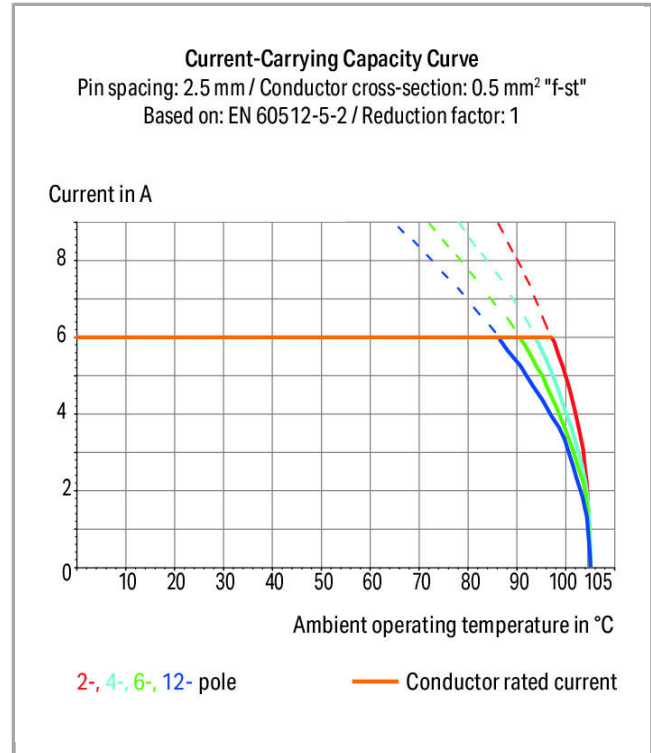

Item description

- Terminal strips with push-buttons and CAGE CLAMP® connection

- Double solder pins for high mechanical stability on PCB
- Ideal for in-the-field wiring thanks to simplified push-button actuation
- Convenient, tool-free operation

## Data

### Electrical data

#### Ratings per IEC/EN 60664-1

Rated voltage (III / 3)	63 V
Rated impulse voltage (III / 3)	2.5 kV
Rated voltage (III / 2)	160 V
Rated impulse voltage (III / 2)	2.5 kV
Rated voltage (II / 2)	320 V
Rated impulse voltage (II / 2)	2.5 kV
Rated current	6 A

#### Approvals per UL 1059

Rated voltage UL (Use Group B)	150 V
Rated current UL (Use Group B)	4 A

#### Approvals per CSA

Rated voltage CSA (Use Group B)	150 V
Rated current CSA (Use Group B)	4 A

### Connection data

Connection technology	CAGE CLAMP®
Actuation type	Push-button
Solid conductor	0.08 ... 0.5 mm <sup>2</sup> / 28 ... 20 AWG
Fine-stranded conductor	0.08 ... 0.5 mm <sup>2</sup> / 28 ... 20 AWG
Fine-stranded conductor with ferrule with plastic collar	0.25 mm <sup>2</sup>
Fine-stranded conductor with ferrule without plastic collar	0.25 mm <sup>2</sup>
Strip length	5 ... 6 mm / 0.2 ... 0.24 inch
Conductor entry angle to the PCB	90°
No. of poles	7
Total number of connection points	7
Total number of potentials	7
Number of connection types	1
Number of levels	1

## Geometrical Data

Pin spacing	2.54 mm / 0.1 inch
Width	19.98 mm / 0.787 inch
Height	18 mm / 0.709 inch
Height from the surface	14 mm / 0.551 inch
Depth	14.4 mm / 0.567 inch
Solder pin length	4 mm
Solder pin dimensions	0.5 x 0.75 mm
Drilled hole diameter (tolerance)	1.1 <sup>(- ... +0.1)</sup> mm

## PCB contact

PCB contact	THT
Solder pin arrangement	over the entire terminal strip, in line
Number of solder pins per potential	2

## Material Data

Color	orange
Material group	I
Insulating material	Polyamide 66 (PA 66)
Flammability class per UL94	V0
Clamping spring material	Chrome nickel spring steel (CrNi)
Contact material	Electrolytic copper (E <sub>Cu</sub> )
Contact plating	tin-plated
Fire load	0.053 MJ
Weight	3.612 g

## Environmental Requirements

Limit temperature range	-60 ... +105 °C
-------------------------	-----------------







## Commercial data

Product Group	4 (Printed Circuit)
Country of origin	CH
GTIN	4044918652155
Customs Tariff No.	85369010000



## Approvals / Certificates

### Country specific Approvals

Logo	Approval	Additional Approval Text	Certificate name

	CCA DEKRA Certification B.V.	EN 60998	NTR NL 6946
	CCA DEKRA Certification B.V.	EN 60998	2153951.01
	CCA DEKRA Certification B.V.	EN 60947-7-4	NTR NL- 7270
	CCA DEKRA Certification B.V.	EN 60947	2169331.03
	CSA DEKRA Certification B.V.	C22.2	1465035
	CSA DEKRA Certification B.V.	C22.2	1465035

## Ship Approvals



Logo	Approval	Additional Approval Text	Certificate name
	ABS American Bureau of Shipping	-	14- HG1241537- PDA
	DNV GL Det Norske Veritas, Germanischer Lloyd	-	TAE000016Z

## UL-Approvals



Logo	Approval	Additional Approval Text	Certificate name
	UL UL International Germany GmbH	UL 1059	E45172

## Compatible products

## ferrule

	<b>Item no.: 216-131</b> Ferrule; Sleeve for 0.25 mm <sup>2</sup> / AWG 24; uninsulated; electro-tin plated	216-131
	<b>Item no.: 216-151</b> Ferrule; Sleeve for 0.25 mm <sup>2</sup> / AWG 24; uninsulated; electro-tin plated	216-151
	<b>Item no.: 216-301</b> Ferrule; Sleeve for 0.25 mm <sup>2</sup> / AWG 24; insulated; electro-tin plated	216-301
	<b>Item no.: 216-321</b> Ferrule; Sleeve for 0.25 mm <sup>2</sup> / AWG 24; insulated; electro-tin plated	216-321

## tools

	<b>Item no.: 210-648</b> Operating tool with partially insulated shaft; Blade (2.5 x 0.4) mm; short; angled	210-648
	<b>Item no.: 210-719</b> Operating tool with partially insulated shaft; Type 1, blade (2.5 x 0.4) mm	210-719

## Marking accessories

	<b>Item no.: 210-331/254-202</b> Marking strips; as a DIN A4 sheet; MARKED; 1-16 (400x); Height of marker strip: 2.3 mm/0.091 in; Strip length 182 mm; Horizontal marking; Self-adhesive	<a href="#">/254-202</a>	210-331
	<b>Item no.: 210-331/254-204</b> Marking strips; as a DIN A4 sheet; MARKED; 17-32 (400x); Height of marker strip: 2.3 mm/0.091 in; Strip length 182 mm; Horizontal marking; Self-adhesive	<a href="#">/254-204</a>	210-331
	<b>Item no.: 210-331/254-206</b> Marking strips; as a DIN A4 sheet; MARKED; 33-48 (400x); Height of marker strip: 2.3 mm/0.091 in; Strip length 182 mm; Horizontal marking; Self-adhesive	<a href="#">/254-206</a>	210-331
	<b>Item no.: 210-331/254-207</b> Marking strips; as a DIN A4 sheet; MARKED; 1-48 (100x); Height of marker strip: 2.3 mm/0.091 in; Strip length 182 mm; Horizontal marking; Self-adhesive	<a href="#">/254-207</a>	210-331

## Downloads

## CAD/CAE - Smart Data

## CAD data

3D Download 234-507	URL	Download
---------------------	-----	----------

## PCB libraries

DesignSpark Library for WAGO PCB Terminal Blocks Compatible with DesignSpark PCB Version 4.x or higher	2.1 Oct 6, 2014	zip 22.5 MB	Download
---	--------------------	----------------	----------



EAGLE Library for WAGO PCB Terminal Blocks Compatible with EAGLE PCB Design Software Version 6.x or higher	2.1 Oct 6, 2014	zip 23.9 MB	<a href="#">Download</a>
TARGET Library for WAGO PCB Terminal Blocks Compatible with TARGET PCB Design Software Version 17.x	1.1.0 Oct 6, 2014	zip 27.1 MB	<a href="#">Download</a>

Subject to changes.